

GRIFform INNOVATIONS®

Molding

1/2" Quarter Round

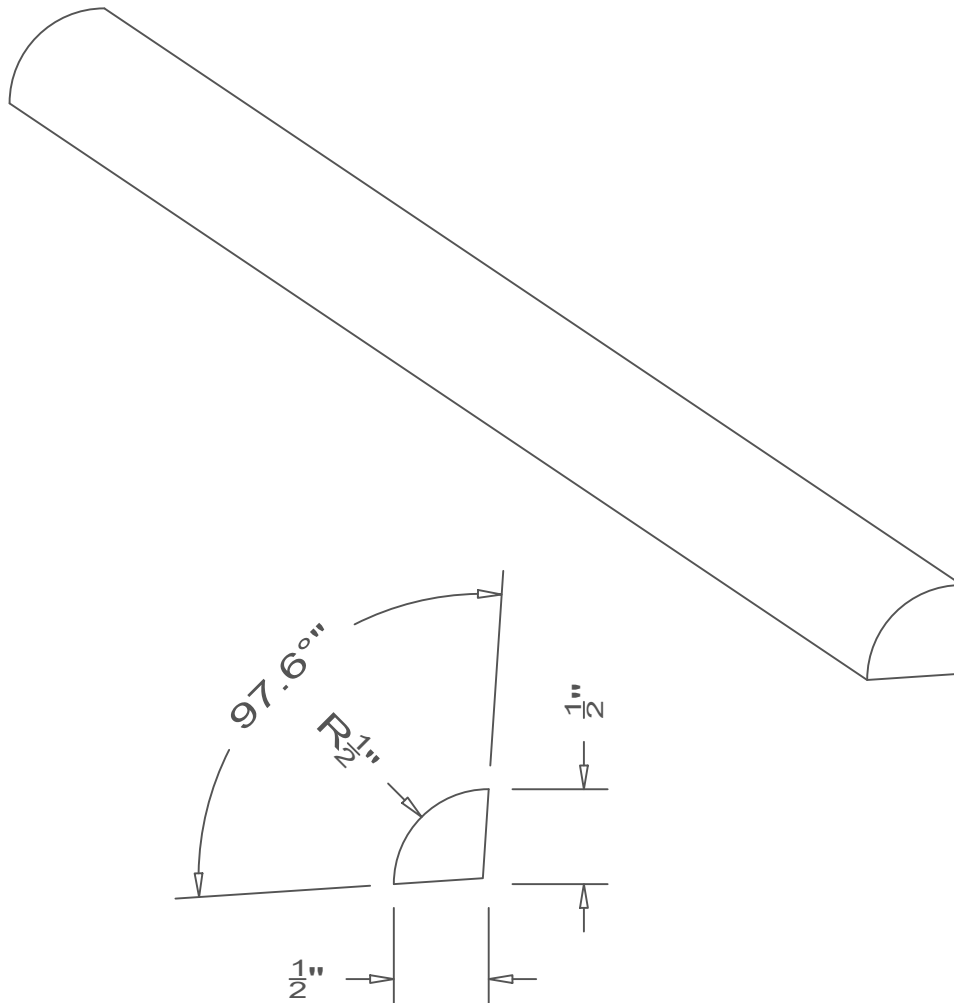

All moldings are available in lengths of 72" and 96".