

# GRIFform INNOVATIONS®

## Classic Shower Pan

### SPC3636S

Drain dimensions are from the outside of the flange to the center of the drain hole.

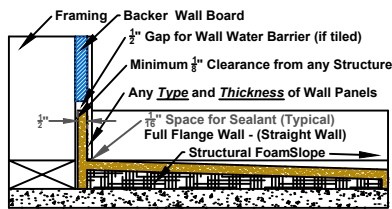
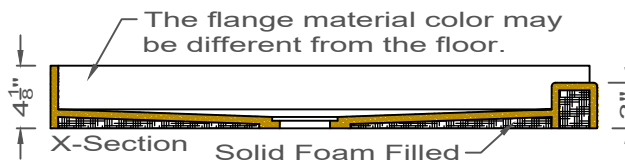
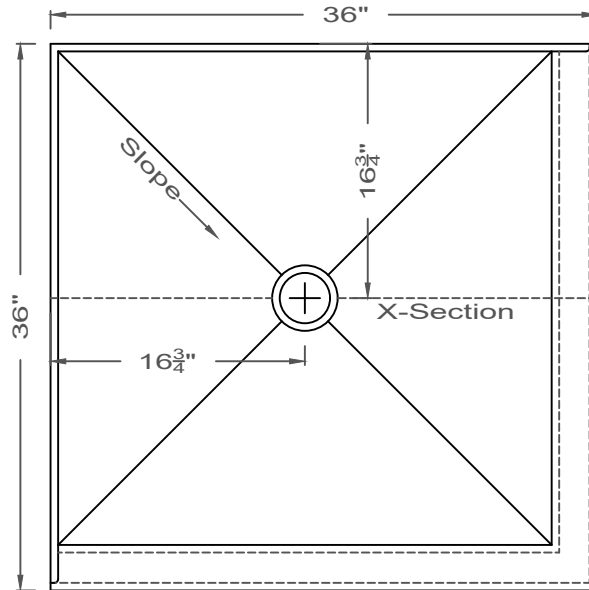

Classic Pan Straight Wall Design

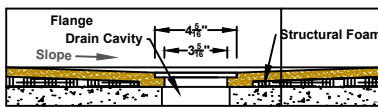

Classic Pan Standard Drain Configuration

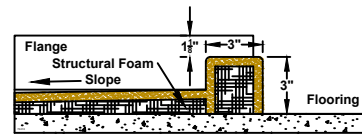

Classic Pan No Drip Threshold Entry